



London

Bänke und Tisch für stark
frequentierte Plätze



london ZL



london ML



Abmessungen

51 kg

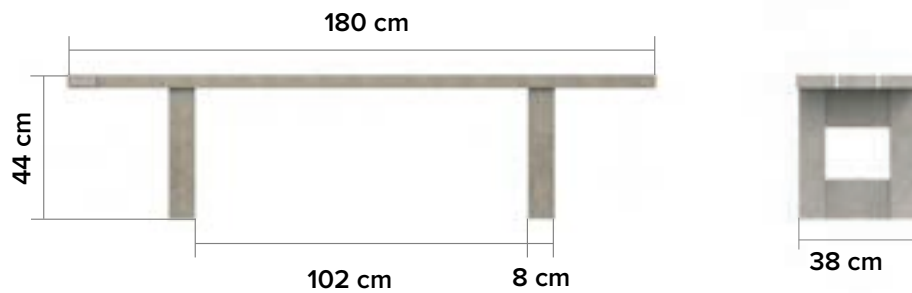

lieferbare Farben

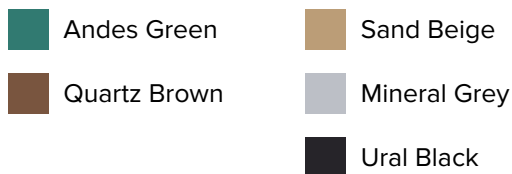

Bicolor Möglichkeiten

Bretter

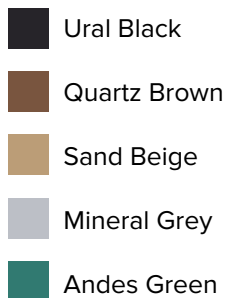

Füße



Hauptvorteile



100% Plastikmüll



Wartungsfrei



Verrottungsfest



Natürliche Oberflächenstruktur



Graffiti leicht entfernbar



Splitterfrei



In der Masse homogen eingefärbt



Wetterfest



komplett recyclebar
im Kreislauf

Abmessungen

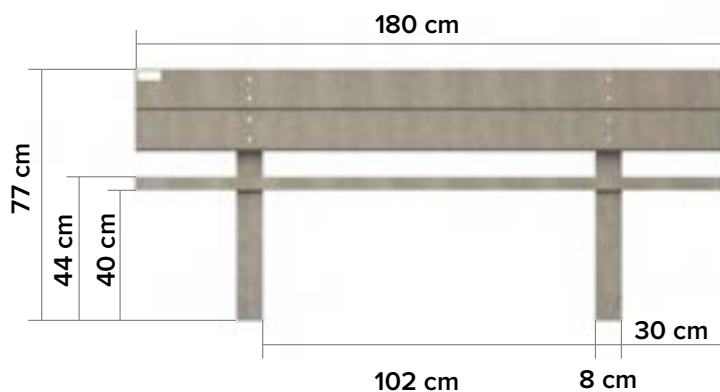

51 kg
mit Lehne: 87 kg



lieferbare Farben

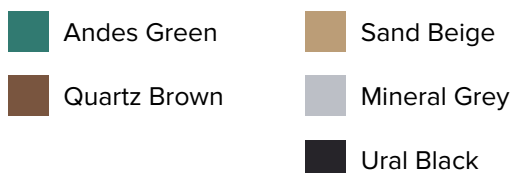

Bicolor Möglichkeiten

Bretter

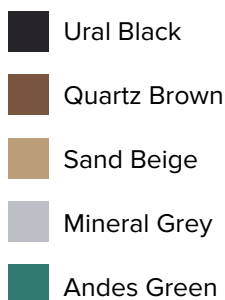

Füße



Hauptvorteile



100% Plastikmüll



Wartungsfrei



Verrottungsfest



Natürliche Oberflächenstruktur



Graffiti leicht entfernbar



Splitterfrei



In der Masse homogen eingefärbt



Wetterfest



komplett recyclebar
im Kreislauf

Verankerung

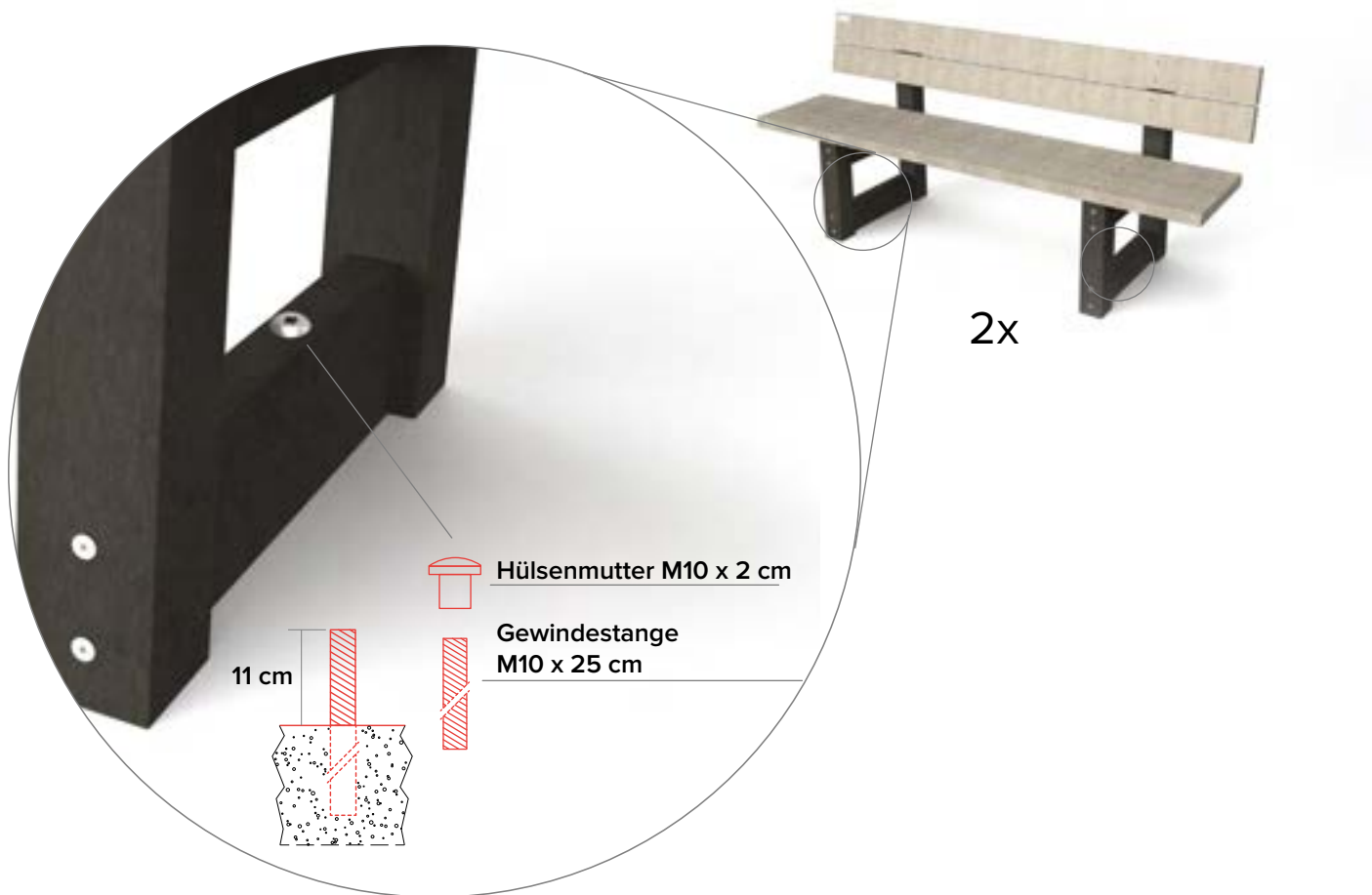

Verstärkung



schön wenn kombiniert mit

